

Bray®

SERIES 40-45

Wafer & Lug Bodies
65-1400 mm (2 1/2" - 54")



THE
HIGH
PERFORMANCE
COMPANY

PRESENTS THE ULTIMATE
HIGH PERFORMANCE VALVE

**BRAY / McCANNALOK
SERIES 40**

**HIGH PERFORMANCE
HIGH PRESSURE
HIGH TEMPERATURE
ZERO LEAKAGE
BUTTERFLY VALVES**

**65-1400 mm
(2 1/2" - 54")**

**WAFFER OFFER
BUBBLE-TIGHT BI-
DIRECTIONAL SHUT-
OFF AND FOR DEAD-
END SERVICE LUG**

**BODIES OFFER BIDIRECTIONAL
BUBBLE-TIGHT SHUT-OFF, BOTH
AT FULL RATED PRESSURE**

WAFFER/LUG BODIES:

**SERIES 40/41 – ANSI CLASS 150
PN10/16 / PN25**

**SERIES 42/43 – ANSI CLASS 300
PN25 / PN40**

**SERIES 44/45 – ANSI CLASS 600
PN40 / PN64**

**TEMPERATURE RANGE: -29°C TO
260°C**

Bray Controls is proud to offer the Bray/McCannalok line of high performance butterfly valves. This product line is recognized as a proven leader with over 30 years of successful service in process industries worldwide. The Series 40's unique, patented design received *Chemical Processing's* Vaaler Award for Best Product shortly after it was introduced. The simple, innovative design offers rugged reliability and extremely easy maintenance in the field. Independent and internal tests have proven Bray/McCannalok's superior service life capability, with bubble-tight shut-off through over 100,000 cycles.

The Series 40 valves can be automated inexpensively with Bray's pneumatic and electric actuators.

When compared to gate, globe, ball, diaphragm and plug valves, the Bray/McCannalok butterfly valve is significantly smaller and lighter weight, therefore installation space, time, and maintenance costs are greatly reduced.

The Bray/McCannalok High Performance Valve delivers the highest quality and highest value available for your requirements.

BODY (A) One piece wafer body style or lug style for dead-end service. Both body styles offer bidirectional sealing as standard to full ANSI Class 150, 300 or 600 ratings. Standard body materials are either carbon steel or stainless steel for excellent corrosion resistance. Extended neck allows for 50mm of pipeline insulation and easy access to stem packing adjustments and actuator mounting.

STEM (B) The high-strength, one piece stem is 17-4 PH Stainless Steel. The valve stem is standardized for interchangeability of Bray actuators.

DISC (C) The disc has been engineered to maximize flow and minimize resistance, providing a high C_v . 316 Stainless Steel is standard.

TAPER PINS (D) Taper pins are precision fit into taper-reamed holes providing a positive connection of maximum strength between the valve disc and stem.

INTERNAL TRAVEL STOP (E) An internal travel stop has been designed to prevent over travel of the disc, minimizing possible seat damage, therefore extending the service life of the seat.

HANDLE AND NOTCH PLATE (F) The heavy-duty, spring release handle and 10 position notch plate allow for positioning the valve disc to precise angle stops between the full open and full closed positions.

BLOW-OUT PROOF STEM (G) The Series 40 High Performance valve features blow-out proof stem protection. A retaining ring is installed between the machined stem groove and gland retainer step providing full retention of the stem in the unlikely event of internal stem failure. (See photo on page 3).

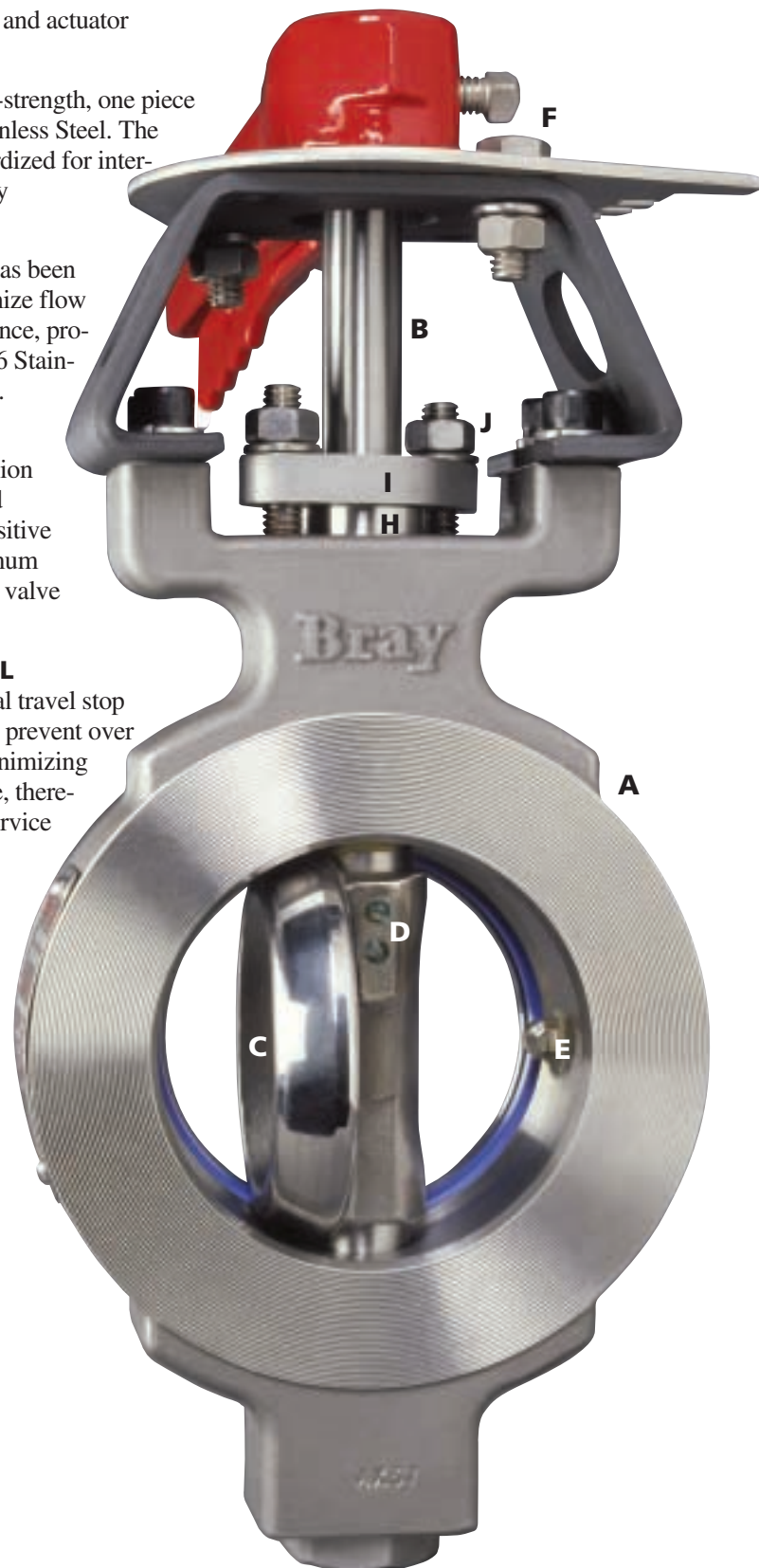

ADJUSTABLE STEM PACKING

The stem packing system features easy access to adjusting hex head nuts without requiring removal of the actuator. The system consists of a gland ring (H), a gland retainer (I), studs, hex head nuts and lock washers (J). A slight 1/4 turn of the hex head nuts is usually all that is required should field adjustment ever be needed. Both hex head nuts must be evenly adjusted and not overtightened.

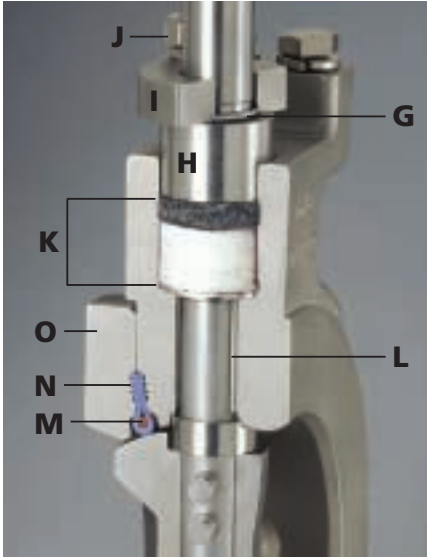

STEM SEAL (K)

The stem seal system provides constant compression for a positive seal around the stem. PTFE packing seals the stem, and a carbon fiber anti-extrusion ring contains the packing. Flexible graphite rings are available for high temperature applications and are standard on fire safe valves.

All Class 150 and Class 300 valves have one set of stem seal packing rings and a stem locating plug with a gasket or O-ring seal in the body base. All Class 600 valves have upper and base twin stem seals which balance axial forces on the stem and disc under all operating conditions, and eliminate any piston effect on the stem.

STEM BEARINGS (L)

Top and bottom bearings, consisting of a 316 Stainless Steel shell with a TFE/glass fabric liner bearing surface, securely support the stem. The stem bearings provide excellent resistance to corrosion and distortion from high temperatures and mechanical loading forces.

SEAT DESIGN

THE HEART OF THE SERIES 40

VALVE The unique, two-part seat assembly consists of a resilient energizer (M) which is totally encapsulated by the RTFE* seat (N). The assembly is locked in the body recess by a full-faced seat retainer (O). This simple, reliable and proven combination results in many exclusive advantages, including:

- The energizer is completely isolated from all contact with the line media by the RTFE seat.
- Serrations in the seat retainer and body recess secure the seat assembly in place regardless of disc position.
- The full-faced retainer is bolted to the body, locking the seat in the correct position. The seat is secured even without the mating flange.
- The closely confined and well supported seat is energized by the disc and line pressure. The higher the pressure, the tighter the seal. In low pressure and vacuum applications, the energized seat offers superior sealing and longer service life than many other designs.
- Line media is sealed to zero leakage in both directions.
- The seat is self-adjusting for wear and temperature changes.
- Seat replacement is extremely easy – just remove the seat retainer, rotate the disc into the closed position and place a new seat assembly in the machined recess of the body. This simple procedure will not disturb the disc or stem.

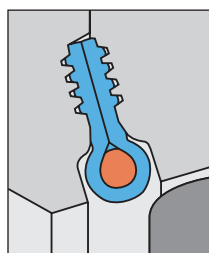

Seat non-compressed as disc approaches.

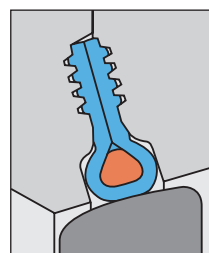

Disc in closed position; with no line pressure.

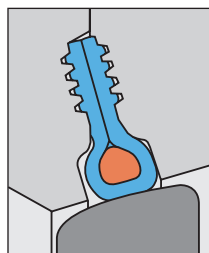

Disc in closed position; line pressure applied from the left.

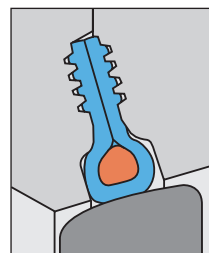

Disc in closed position; line pressure applied from the right.

DOUBLE OFF-SET STEM AND DISC DESIGN

The double offset design of the Series 40 assures reduced seat wear and bidirectional, zero leakage, shut off throughout the full pressure range.

At the initial point of disc opening, the offset disc produces a cam-like action, pulling the disc from the seat. This cam-like action reduces seat wear and eliminates seat deformation when the disc is in the open position. When open, the disc does not contact the seat, therefore seat service life is extended and operating torques are reduced. As the valve closes, the cam-like action converts the rotary motion of the disc to a linear type motion to effectively push the disc onto the seat. The wiping action of the disc against the seat prevents undesirable material build-up from slurries or suspended solids.

The taper pins carry virtually equal loads while anchoring the disc to the stem, permitting accurate disc closure for consistent sealing and positive shut off.

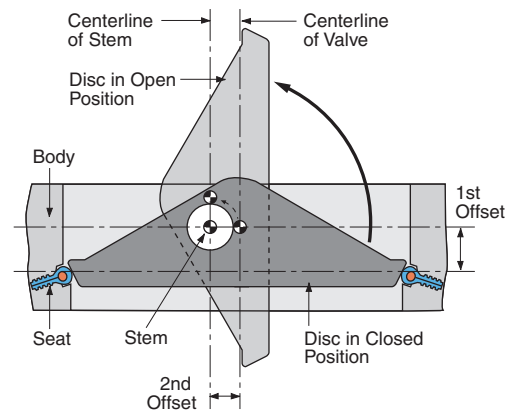

For over 30 years the reliability of the Bray/McCannalok has been conclusively proven, both in lab tests and thousands of field applications. After a test of over 100,000 cycles at 720 psi, the seat remained in excellent condition, continuing to provide a bidirectional bubble-tight seal. Even after more than 878,000 cycles at 2 psi, the Series 40 still sealed bubble-tight in both directions.

*RTFE is the common designation for RPTFE as supplied by Bray.

BRAY/McCANNALOK HIGH PERFORMANCE SERIES 40 VALVES ARE AVAILABLE WITH PROVEN BIDIRECTIONAL FIRE SAFE SEATS ON SIZES 65mm-600mm ANSI CLASS 150 AND 65MM-400MM CLASS 300 WAFER & LUG BODIES

FOR RELIABLE CONTROL OF FLAMMABLE AND

HAZARDOUS FLUIDS IN PETROLEUM, PETRO-CHEMICAL, CHEMICAL AND OTHER HIGH-RISK APPLICATIONS, THE FIRE SAFE DESIGN COMBINES SUPERIOR PERFORMANCE, EXTENDED SERVICE LIFE AND COMPLIANCE WITH THE MOST DEMANDING WORLD-WIDE FIRE-TEST STANDARDS – BEFORE, DURING AND AFTER A FIRE!

In normal service, the FIRE SAFE combination resilient/metal seat seals bubble-tight in both directions of line media flow through the full rated pressure and temperature ranges. When closed, the disc remains compressed against the resilient mechanically loaded seat, which is securely locked in place by a full-faced retainer. Line media pressure strengthens the seal.

In the event of a fire, if excessive heat destroys the resilient seat materials, either partially or completely, the seat provides a constant metal-to-metal backup seal.

In real-world fire conditions, line pressure is immediately reduced and the entire area is hosed down. The resulting pressure drop and rapid cool down causes many valves to fail. The FIRE SAFE design does not rely on line media pressure to seal, therefore the valve offers superior low pressure performance than competitive designs. The Inconel® metal seat functions as a spring mechanism, which allows for expansion and contraction without breaking contact with the disc. Additionally, the Inconel seat offers better corrosion and heat resistance and greater strength than the stainless steel seats commonly used.

The Bray/McCannalok delivers proven fire safe protection not only in the lab, but also where it counts the most – in the field.



The adjustable stem sealing packing system is composed of flexible graphite and formed graphite rings. These ring materials offer maximum stem sealing capability. The packing can be easily adjusted by a slight turn of the readily accessible hex head nuts.



FIRE SAFE SEAT OPERATION

The seat assembly in normal service contacts the disc with both the resilient seat material and metal seat. During and after a fire, when the resilient material has been partially or completely destroyed, the metal seat provides a positive seal by remaining in constant contact with the disc in either direction of media flow.

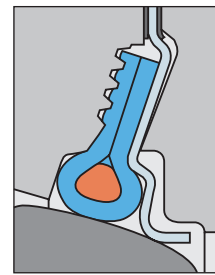

The FIRE SAFE Seat in normal service

Bidirectional Resilient Seat with O-ring Energizer / Inconel® Seat

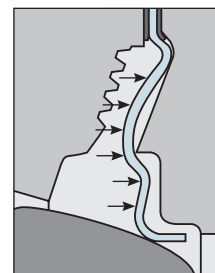

Seat after fire, with disc sealing load and line media pressure acting on the seat from the left. (Seat retainer downstream)

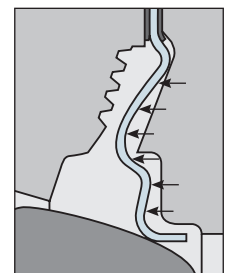

Seat after fire, with disc sealing load and line media pressure acting on the seat from the right. (Seat retainer upstream)

FIRE-TEST STANDARDS API 607 4th Edition Certified.

The Bray/McCannalok FIRE SAFE has been thoroughly tested and meets or exceeds the latest international fire test standards. Since its introduction the FIRE SAFE design has passed field applications and lab tests with flying colors, delivering superior performance under the most demanding conditions.

* Inconel® is a registered trademark of Inco Alloys International, Inc.

Bray/McCannalok Series 40 valves handle a wide range of conditions and media, such as corrosive chemicals, water, gases, acids, alkalis, hydrocarbons plus many other fluids. Bray's standard valve line has been specifically designed to meet most applications. When applications demand special requirements, Bray offers valves and materials that meet these needs. Services and optional materials include:

VACUUM

Standard Series 40 valves with TFE seats are recommended for vacuum service down to .02 mm Hg absolute pressure, or 20 microns. For vacuum service down to 1×10^{-3} mm Hg absolute pressure, or 1 micron, specially prepared valves are recommended. Under certain conditions, these valves serve well in the high vacuum range down to 1×10^{-6} mm Hg absolute pressure.

STEAM

Series 40 valves are specifically designed for a wide range of high temperature and high pressure applications including on-off and modulating control of hot water, condensed water or chilled water. The Series 40 valve is rated 10.3 bar (150 psi) saturated steam at 185°C for on-off applications. For modulating service, the Series 40 is rated 3.5 bar at 148.8°C. Use of the standard RTFE seat is recommended for this service.

DRY CHLORINE – Gas or Liquid

Special materials as well as assembly and testing procedures are applied to assure bubble-tight closure in these critical services.

SEA WATER

Series 40 valves have been successfully installed in power plants, desalination plants and deep sea drilling projects. Duplex, super duplex and super-austenitic stainless trims can be provided for sea water service. Higher alloy materials are available.

Please consult your Bray representative for specific recommendations regarding your requirements.



ASH HANDLING AND ABRASIVE

For applications where flow velocity and differential pressure are low, RTFE or UHMWPE seats and electroless nickel plated discs are recommended. For applications requiring improved resistance to wear and particles of higher hardness, a stellite faced disc and FIRE SAFE design are recommended.

CAUSTIC

Valve materials must be selected for sufficient corrosion requirements. Stainless steel is recommended for sodium and potassium hydroxide applications.

HEATING, VENTILATION AND AIR CONDITIONING (HVAC)

Series 40 valves can be used for damping or balancing water flow, main stop valves, block valves, throttling valves, and control of pump suction or discharge.

OXYGEN

Series 40 valves for critical gaseous oxygen service are specially prepared, cleaned, inspected, assembled and tested to ensure removal of all burrs, sharp edges, dirt, hydrocarbon oil or grease, and other contaminants. Each valve is individually wrapped and sealed in polyethylene before shipment.

SOUR GAS

Selected materials of construction meeting NACE standards (MR-01-75) permit ready application and maximum serviceability in these difficult services.

DEAD-END SERVICE

Bray/McCannalok lug bodies for bidirectional dead-end service are offered as standard in full ANSI Class 150, 300 and 600 ratings.

U.S. COAST GUARD APPROVED

The Bray/McCannalok High Performance Valve has been approved by the U.S. Coast Guard and American Bureau of Shipping for category A and P applications.

Series 40 valves can be optionally supplied in a number of different seat and body materials, including:

- PTFE and UHMWPE seats with resilient energizer.
- Fluorosilicone inner O-rings for methylene chloride service.
- FIRE SAFE graphite/carbon fiber or similar packing for fire safe or high temperature service.
- Hastelloy C bodies for hydrogen-cyanide service.
- Aluminum bronze bodies for marine environments.
- Longer stem lengths to accommodate differing control areas.
- Alloy 20 trim for sulfuric acid service.
- Monel discs for Chlorine service.
- Duplex, Superduplex and Super-austenitic stainless trims for salt water services.
- Many other materials are also available, please consult the Bray factory.



DIMENSIONS

Dimensions are in mm and weights in kgs.

Weights are for Cast Steel bodies, except when noted by *.

* Flame cut body weights.

Flame Cut Steel and SS bodies vary. Please consult factory.

CLASS 150 Series 40 ANSI Class 150 / PN10/16 / PN25

Series 41 WEIGHTS

Valve Size	A	B	C [†]	D	E	F	Mounting Data			G	H	J	K	L	*Lug Bolting Data			Series 40	Series 41
							PCD	No. Holes	Hole Dia.						PCD	No. Holes	Threads		
65	2 1/2	121	48	58	97	162	111	70	4	9.6	16	11	32	64	20			6	6
80	3	133	48	73	104	168	111	70	4	9.6	16	11	32	64	20			7	7
100	4	171	52	94	120	191	111	70	4	9.6	16	11	32	64	19			9	10
125	5	191	57	122	129	191	130	70	4	9.6	19	13	32	114	24			12	15
150	6	219	57	149	141	203	130	70	4	9.6	19	13	32	114	24			15	21
200	8	273	61	198	176	241	130	125	4	13.5	22	16	32	114	24			21	24
250	10	332	70	248	217	273	155	125	4	13.5	30	22	51	114	27			36	43
300	12	394	78	298	259	311	155	125	4	13.5	30		51	114	29			56	62
350	14	445	95	328	304	368	197	125	4	13.5	35	10x10	51	165	36			94	103
400	16	503	104	373	329	451	264	165	4	20.5	50	12x10	64	165	42			142	156
450	18	544	117	422	359	508	264	165	4	20.5	50	12x10	64	165	47			182	200
500	20	601	128	470	388	578	264	165	4	20.5	64	15.8x15.8	102	165	52			239	274
600	24	711	152	572	463	635	391	254	8	17.0	76	19x19	102	298	62			369	422
650	26	749	165	568	488	635	391	254	8	17.0	76	19x19	102	298	71			440	581
700	28	823	165	672	522	679	391	254	8	17.0	76	19x19	152	298	71			506	590
750	30	876	191	719	543	730	495	298	8	20.5	89	22.3x15.8	133	343	79			669	789
800	32	956	191	767	568	762	495	298	8	20.5	88.9	22.3x15.8	133	343	82			748	934
850	34	1006	197	765	606	762	495	298	8	20.5	89	22.3x15.8	133	343	85			857	1061
900	36	1033	210	864	642	838	495	298	8	20.5	88.9	22.8x15.8	133	343	92			889	1179
1000	40	1295	241	940	692	940	495	298	8	20.5	114	25.4x19.05	133	343	111			1746	1792
1050	42	1354	241	992	746	965	495	298	8	20.5	114	25.4x19.05	133	343	111			1928	1950
1200	48	1372	254	1171	841	1070	610	356	8	31.7	127	31.7x22.3	152	406	114			2091	2576
1400	54	1686	273	1332	906	1156	610	356	8	31.7	152	38.1x25.4	165	406	121			3221	3270

Refer to Separate Data Sheets

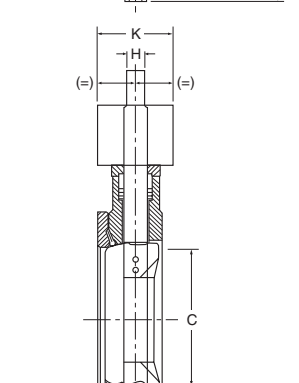
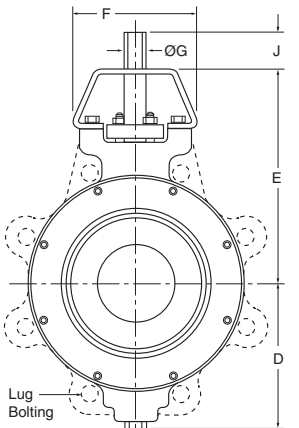
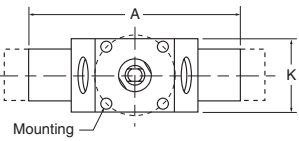

† C dimension is absolute minimum pipe ID at valve face (without gasket).
 ** (H=Flats)

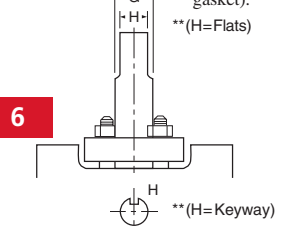

CLASS 300 Series 42 ANSI Class 300 / PN25 / PN40

Series 43 S42 S43

65	2 1/2	121	48	58	97	162	111	70	4	10	16	11	32	64	20			6	7
80	3	133	48	73	104	168	111	70	4	10	16	11	32	64	20			7	8
100	4	171	52	94	120	191	111	70	4	10	16	11	32	64	19			9	10
125	5	210	57	122	130	203	130	70	4	10	19	13	32	114	24			15	18
150	6	226	61	146	159	222	130	125	4	13	22	16	32	114	25			18	24
200	8	278	72	192	192	254	155	125	4	13	30	22	51	114	28			31	40
250	10	337	83	240	238	289	155	125	4	13	35	10x10	51	114	33			51	65
300	12	395	92	287	277	343	197	125	4	13	35	10x10	51	165	36			78	98
350	14	455	118	289	318	464	264	165	4	21	50	12x10	64	165	54			149	201
400	16	506	136	363	358	533	264	165	4	21	64	15.8x15.8	102	165	64			206	269
450	18	559	152	381	392	533	391	254	8	17	64	15.8x15.8	102	298	67			274	388
500	20	612	161	419	427	565	391	254	8	17	76	19x19	102	298	74			354	476
600	24	734	182	525	503	667	495	298	8	21	89	22.2x15.8	133	343	86			572	780
750	30	892	228	681	594	819	610	356	8	32	114	25.4x19	133	406	111			1025	1365
900	36	1067	271	842	689	821	610	356	8	32	127	31.8x22.2	152	406	133			1506	1996
1050	42	1289	292	988	743	1029	660	406	8	38	152	18.1x25.4	165	475	130			2268	2132
1200	48	1467	318	1162	842	1137	737	483	12	38	178	44.4x38.1	191	559	140			—	3175

Refer to Separate Data Sheets

CLASS 600 Series 44 ANSI Class 600 / PN40 / PN64

Series 45 S44 S45

80	3	147	56	70	145	178	130	70	4	10	19	13	32	114	23			11	14
100	4	178	70	90	179	216	130	125	4	13	22	16	32	114	29			19	26
150	6	248	85	137	218	248	155	125	4	13	30	22	51	114	38			36	54
200	8	300	107	175	274	311	197	165	4	21	35	10x10	51	165	48			70	103
250	10	358	122	216	371	432	264	165	4	21	50	12x10	64	165	55			127	181
300	12	418	140	257	399	464	264	165	4	21	50	12x10	64	165	64			175	248
350	14	458	155	276	444	502	391	254	8	17	64	15.8x15.8	102	298	74			249	340
400	16	518	178	321	493	552	391	254	8	17	76	19.05x19.05	102	298	87			341	499
450	18	588	197	371	535	603	495	298	8	21	89	22.3x15.8	133	342.9	91			494	667
500	20	639	216	416	590	654	495	298	8	21	102	25.4x19.05	133	342.9	98.6			617	839
600	24	746	232	505	704	787	610	356	8	32	127	31.7x22.3	152	406	100			980	1315
750	30	914	286	673	800	914	660	406	8	38	152	38.1x25.4	152	475	127			1588	2132

Refer to Separate Data Sheets

CLASS 150 Series 40 / 41 ANSI Class 150 / PN10/16 / PN25

Valve Size		Disc Position (degrees)								
mm	ins	90°	80°	70°	60°	50°	40°	30°	20°	10°
65	2 1/2	160	136	100	78	50	30	16	8	3
80	3	185	178	155	123	87	56	32	14	4.8
100	4	375	365	315	250	175	115	63	31	10
125	5	790	675	500	360	238	146	78	41	16
150	6	1350	1070	750	510	330	218	140	81	35
200	8	2800	2230	1590	1060	685	456	280	165	65
250	10	4300	3450	2430	1630	1050	700	450	250	100
300	12	6650	5330	3750	2530	1630	1080	700	390	155
350	14	7650	6100	4300	2900	1890	1250	810	450	175
400	16	9800	7860	5510	3700	2420	1530	1020	580	230
450	18	10500	9100	6960	5100	3520	2220	1180	500	170
500	20	13500	11700	8800	6500	4500	2820	1530	640	200
600	24	20000	17100	12800	9570	6640	3880	2200	920	240
650	26	20000	17100	12800	9570	6640	3880	2200	920	240
700	28	28000	23900	18200	13500	9300	5700	3100	1300	290
750	30	32000	27300	20900	15500	10700	6700	3600	1510	320
800	32	34000	29100	22300	16500	11400	7150	3850	1610	340
850	34	34000	29100	22300	16500	11400	7150	3850	1610	340
900	36	48500	41100	31700	23200	16400	10200	5430	2260	480
1000	40	62000	55200	44000	33300	23800	15200	8600	3520	670
1050	42	65000	58000	46100	35000	25000	16000	9000	3700	700
1200	48	91000	80900	63700	43600	29100	20000	11000	4600	920
1400	54	125000	111000	87500	60000	40000	27500	15000	6000	1200

CLASS 300 Series 42 / 43 ANSI Class 300 / PN25 / PN40

65	2 1/2	160	136	100	78	50	30	16	8	3
80	3	185	178	155	123	87	56	32	14	4.8
100	4	375	365	315	250	175	115	63	31	10
125	5	790	675	500	360	238	146	78	41	16
150	6	1000	875	710	530	370	240	138	79	26
200	8	2000	1720	1360	950	630	405	240	121	47
250	10	2650	2250	1740	1200	780	510	295	150	61
300	12	4000	3400	2500	1690	1100	710	430	220	92
350	14	4100	3500	2600	1770	1200	830	490	240	100
400	16	7800	6540	4550	2970	1840	1160	730	420	180
450	18	9500	8000	6170	4530	3110	1970	1080	440	94
500	20	11000	9570	7300	5400	3720	2330	1250	530	110
600	24	18000	15100	11400	8570	5920	3700	2000	830	180
750	30	29000	24400	18900	13700	8500	6000	3230	1330	290
900	36	45000	38100	29200	21000	14800	9100	4660	1730	380
1050	42	60000	54000	42000	30000	19000	13000	7500	2600	450
1200	48	83000	74000	58000	41000	26000	17000	10000	4400	800

CLASS 600 Series 44 / 45 ANSI Class 600 / PN40 / PN64

80	3	165	158	135	103	67	46	12	8	3
100	4	300	270	210	150	95	70	45	30	5
150	6	850	765	600	425	270	200	130	70	15
200	8	1500	1350	1050	750	480	345	209	78	20
250	10	2200	1970	1540	1100	700	500	300	140	40
300	12	3100	2790	2170	1550	1000	680	400	190	55
350	14	3900	3300	2400	1570	1100	730	420	200	70
400	16	5000	4200	2900	1900	1200	800	500	250	95
450	18	6000	5000	3900	2800	1900	1200	660	290	130
500	20	8000	6900	5300	3900	2700	1700	950	400	143
600	24	11000	9300	7000	5200	3600	2250	1200	500	180
750	30	15000	13000	10000	8400	5100	2800	1650	600	200

ANSI 150 Series 40 / 41

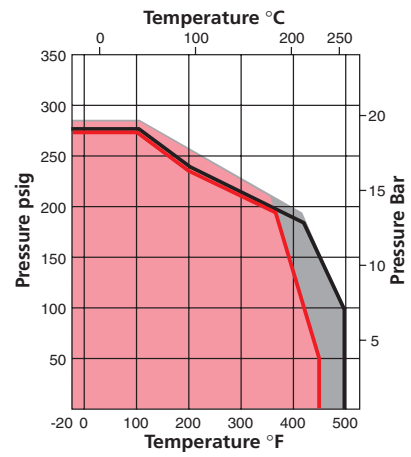

ANSI 300 Series 42 / 43

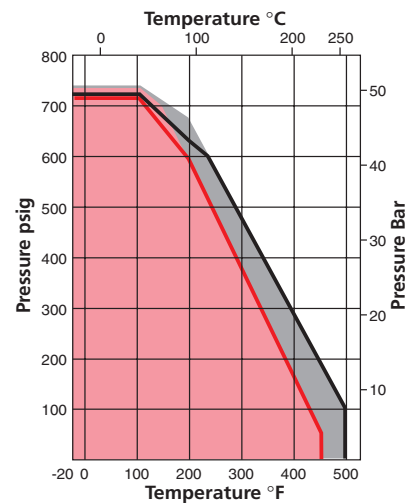

ANSI 600 Series 44 / 45

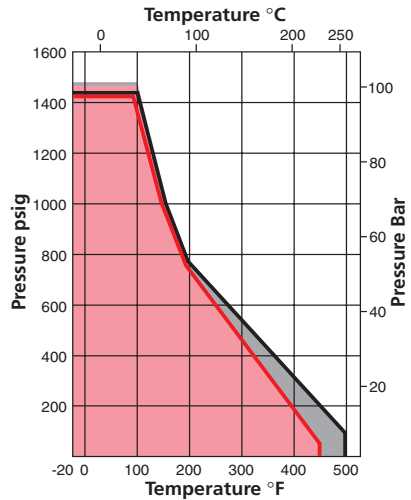

- Carbon Steel Bodies RTFE Seats
- Stainless Steel Bodies RTFE Seats
- Carbon Steel Bodies PTFE Seats
- Stainless Steel Bodies PTFE Seats

Note: Refer to Bray Technical Bulletin No.1168 for additional information on Pressure/Temperature Curves.

C_v is defined as the volume of water in U.S.G.P.M. that will flow through a given restriction or valve opening with a pressure drop of one (1) p.s.i. at room temperature. Recommended control angles are between 25°–70° open. Preferred angle for control valve sizing is 60°–65° open.

SEATING/UNSEATING TORQUES (NM)

The values in the following Torque Charts for standard valves are for normal, wet media applications. Note that seating/unseating torque is always lower with the seat retainer installed upstream. Please consult Bray Technical Bulletin No. 1146 for discussion on service torque classes applicable to standard valves. If the media is lubricious, such as oil, the values in the Torque Charts should be multiplied by 0.9. If the media is abrasive or dry and thus a severe application, the values in charts should be multiplied by 1.3. For firesafe

CLASS 150 Series 40 / 41 Standard

Valve Size mm	System Pressure ΔP (Bar)							
	Less than 10.3		10.3 – 13.8		13.8 – 17.2		17.2 – 19.6	
	Retainer Upstream	Retainer Downstream	Retainer Upstream	Retainer Downstream	Retainer Upstream	Retainer Downstream	Retainer Upstream	Retainer Downstream
65	19	23	21	27	24	32	24	34
80	21	25	24	29	25	34	26	36
100	31	36	34	42	36	47	36	52
125	62	73	72	90	80	106	82	118
150	78	92	87	108	93	124	95	136
200	145	169	158	192	169	220	177	237
250	271	316	298	373	319	425	324	463
300	395	463	452	565	497	667	514	734
350	610	712	669	836	723	960	751	1073
400	870	1028	1021	1277	1141	1525	1186	1695
450	1345	1582	1537	1921	1695	2260	1740	2486
500	1729	2034	1932	2407	2090	2791	2135	3051
600	2785	3277	3127	3909	3390	4531	3480	4971
650	2785	3277	3127	3090	3390	4531	3480	4971
700	3938	4632	4248	5310	5005	6689	5028	7175
750	4514	5310	4854	6067	5740	7649	5932	8474
800	5084	5988	5514	6892	6508	8677	6644	9491
850	5084	5988	5514	6892	6508	8677	6644	9491
900	6101	7231	7321	9152	8304	11073	8700	12428
1000	7005	8248	8316	10395	9321	12428	9570	13671
1050	8022	9378	9491	11863	10762	14349	11411	16157
1200	11073	12993	13739	17174	16100	21467	17162	24518
1400	15366	18078	19162	23953	22371	29941	23885	34121

CLASS 150 Series 40 / 41 Fire Safe

65	77	81	78	87	79	92	80	95
80	85	90	86	94	87	98	88	102
100	96	102	99	111	101	119	103	124
125	160	169	166	184	169	198	181	209
150	188	198	191	212	203	226	215	237
200	294	316	304	333	311	350	323	362
250	441	475	463	512	480	549	497	576
300	734	780	746	830	757	880	780	915
350	1390	1469	1424	1582	1491	1751	1537	1921
400	1717	1808	1785	1989	1842	2169	1844	2305
450	2034	2147	2135	2373	2147	2542	2169	2712
500	2463	2599	2542	2825	2689	3164	3254	4067
600	3503	3728	3864	4293	4226	4971	5694	7118

CLASS 300 Series 42 / 43 Standard

Valve Size mm	System Pressure ΔP (Bar)							
	Less than 10.3		10.3 – 24		24 – 38		38 – 51	
	Retainer Upstream	Retainer Downstream	Retainer Upstream	Retainer Downstream	Retainer Upstream	Retainer Downstream	Retainer Upstream	Retainer Downstream
65	19	23	33	41	43	58	53	76
80	21	25	35	43	45	60	55	78
100	31	36	47	60	62	82	79	113
125	62	73	113	141	157	209	203	288
150	96	113	149	186	194	260	237	339
200	179	209	280	350	365	486	418	599
250	316	373	497	621	644	859	791	1130
300	480	565	750	938	975	1299	1186	1695
350	825	972	1211	1514	15479	2068	1740	2486
400	1345	1582	1943	2429	2463	3277	3005	4293
450	1729	2034	2440	3051	3062	4079	3559	5084
500	2305	2712	3322	4147	4180	5570	4824	6892
600	3649	4293	5152	6440	6497	8666	7513	10734
750	7683	9039	11479	14349	14575	19433	16609	23727
900	11428	13445	16270	20337	20337	27116	22936	32766
1000	13061	15366	18981	23727	25083	33444	31478	44968
1200	14406	16948	24585	30732	36268	48357	45555	65079

valves, the operating torque should be taken directly from the charts, with due consideration for the location of the seat retainer. No reduction or multiplication factors should be used to determine torque of firesafe valves.

These torque figures are seating and unseating torques. Dynamic torques should also be determined in the event dynamic torques are greater than the seating/unseating torques. Refer to Bray Technical Bulletin No. 1172 for dynamic torques.

ANSI 300 Series 42 / 43 Fire Safe

Valve Size mm	System Pressure ΔP (Bar)			
	Less than 10.3		10.3 – 13.8	
	Retainer Upstream	Retainer Downstream	Retainer Upstream	Retainer Downstream
65	77	81	88	97
80	88	90	97	107
100	96	102	122	136
125	160	169	234	260
150	226	237	295	328
200	339	356	437	486
250	780	825	1037	1152
300	1181	1243	1491	1661
350	2039	2147	2440	2712
400	3005	3164	3864	4293

Valve Size mm	System Pressure ΔP (Bar)			
	13.8 – 17.2		17.2 – 19.6	
	Retainer Upstream	Retainer Downstream	Retainer Upstream	Retainer Downstream
65	97	114	99	124
80	106	124	108	136
100	144	169	154	192
125	298	350	325	407
150	356	418	389	4486
200	528	621	560	701
250	1248	1469	1356	1695
300	1767	2079	1898	2373
350	2497	2938	3774	3164
400	4226	4971	4429	5536

CLASS 600 Series 44 / 45

Valve Size mm	System Pressure ΔP (Bar)			
	Less than 10.3		10.3 – 41.4	
	Retainer Upstream	Retainer Downstream	Retainer Upstream	Retainer Downstream
80	45	54	79	98
100	96	108	145	181
150	164	192	289	362
200	395	463	651	813
250	802	938	1085	1356
300	1141	1333	1265	1582
350	1345	1582	2169	2712
400	1582	1864	3209	4011
450	1830	2147	3887	4858
500	2407	2825	5152	6440
600	7494	4406	8022	10056
750	8022	9378	15479	19433

Valve Size mm	System Pressure ΔP (Bar)			
	41.4 – 72.4		72.4 – 102	
	Retainer Upstream	Retainer Downstream	Retainer Upstream	Retainer Downstream
80	102	136	113	164
100	179	237	215	305
150	390	520	463	655
200	859	1141	1107	1582
250	1525	2034	1898	2712
300	2203	2938	2373	3390
350	2802	3728	3390	4858
400	3898	5197	5141	7344
450	5536	7344	7276	10395
500	7457	9943	9830	14010
600	10621	14123	13897	19772
750	20337	27116	24518	35025

MATERIALS OF CONSTRUCTION

Item	Name	Material
1	Body	Stainless Steel, ASTM A351 GR CF8M Carbon Steel, ASTM A216 GR WCB /A516 GR 70
2	Disc	Stainless Steel, ASTM A351 GR CF8M – Standard with Electroless Nickel Plating on disc edge – FIRE SAFE
3	Stem	17-4 PH SS, ASTM A564-Type 630
4	Taper Pins	17-4 PH SS, ASTM A564-Type 630
5	Disc Spacers	316 Stainless Steel, ASTM 276 Type 316
6	Bearing Assembly	316 Stainless Steel with TFE & Glass Fabric Liner
7	Gland Ring	316 Stainless Steel, ASTM 276 Type 316
8	Stem Seal	PTFE rings plus 1 Carbon Fiber ring – Standard Valve Flexible Graphite rings – FIRE SAFE Valve
9	Thrust Washer	316 Stainless Steel, ASTM 276 Type 316
10	Retaining Ring	18-8 Stainless Steel
11	Gland Retainer	316 Stainless Steel, ASTM A351 CF8M Carbon Steel, ASTM A216 GR WCB /A516 GR 70
12	Stud	316 Stainless Steel, ASTM A193-B8M
13	Lock Washers	18-8 Stainless Steel
14	Hex Nut	18-8 Stainless Steel
15	Seat Assembly	RTFE [^] with Silicone Rubber Energizer PTFE with Silicone Rubber Energizer
16	Seat Retainer Plate	Stainless Steel, ASTM A351 CF8M /A240-316 Carbon Steel, ASTM A216 GR WCB /A516 GR 70
17	Cap Screws	18-8 Stainless Steel Alloy Steel
18	Gasket	PTFE – Standard Valve Flexible Graphite – FIRE SAFE Valve
19	Locating Plug	316 Stainless Steel, ASTM 276 Type 316/A240-316 Carbon Steel, Phosphate Coated
20	Mounting Plate	18-8 Stainless Steel Carbon Steel, Phosphate Coated
21	Cap Screws	18-8 Stainless Steel Alloy Steel
22	Lock Washers	18-8 Stainless Steel Alloy Steel
23	Metal Seat ^{‡‡}	Inconel [®] 718, ASTM B670
24	Gasket ^{‡‡}	Flexible Graphite

Not Shown: Belleville Washer and Grounding Washer: 18-8 Stainless Steel, for 14"–54" Class 150, 14"–48" Class 300 and 10"–30" Class 600 valves

[^] RTFE is supplied by Bray as RPTFE (reinforced polytetrafluoroethylene).

^{‡‡} FIRE SAFE Valve only.

Other materials are available, please consult factory for your specific application.

Exploded View
Series 40

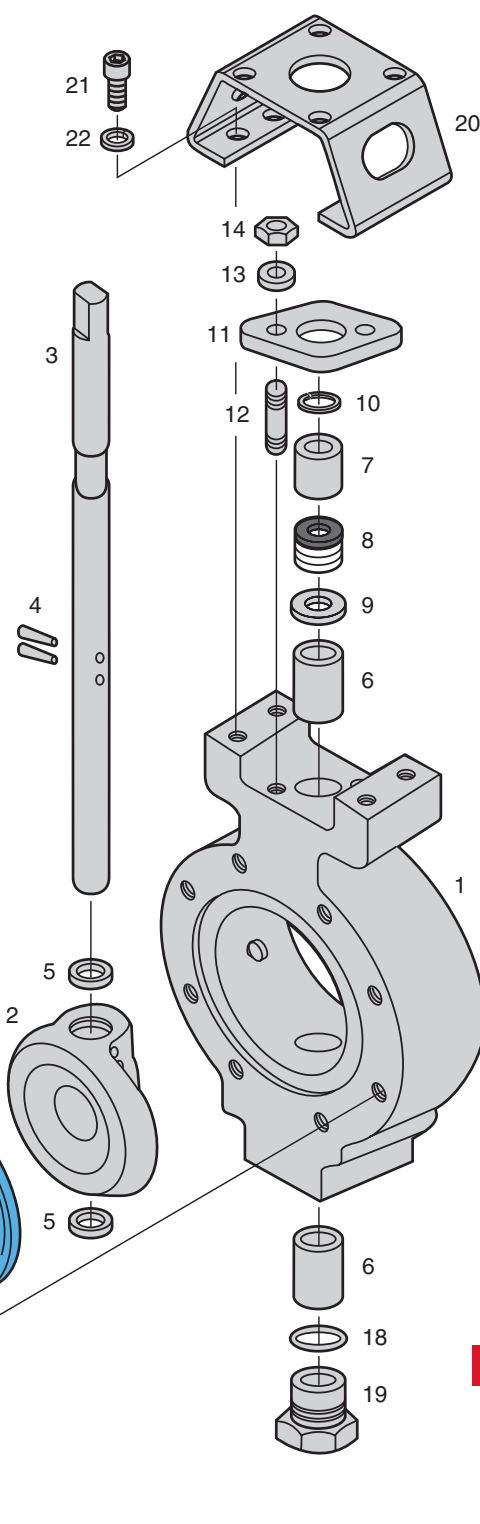

BLOW-OUT PROOF STEM

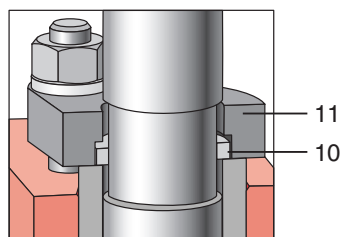

FIRE SAFE Valve

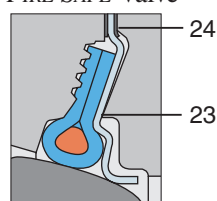



IN ADDITION TO THE EXCELLENT FEATURES OF THE SERIES 40, THIS HIGH PERFORMANCE BUTTERFLY VALVE OFFERS SUPERIOR ADVANTAGES OVER OTHER VALVES.

When matched against comparably rated plug, globe, gate, ball and diaphragm valves, the reduced weight and space requirements of the Series 40 is readily apparent.

The cost savings of installation and maintenance are substantial.

The torque requirements of the High Performance Series 40 Butterfly Valve are also significantly lower. For example, an 200mm Series 40 Class 150 valve weighs 20.5 kg and has a maximum torque of 169 Nm. Comparable plug valves weigh 144 kg with 412 Nm of torque, and ball valves weigh 71 kg with 723 Nm

of torque. A gate valve with a comparable rating weighs 140 kg and requires a linear unit for actuation. Therefore, the Series 40 Butterfly Valve requires a much smaller actuator than other valves.

Economy, efficiency and proven superior performance establish the Bray/McCannalok as the premier solution for demanding high pressure applications.



DIRECT MOUNTING OF COMPACT, HIGH TORQUE BRAY PNEUMATIC AND ELECTRIC ACTUATORS PROVIDE LOW COST AUTOMATION FOR ON-OFF AND CONTROL SERVICES.

The Series 40 valves can be automated inexpensively with Bray's pneumatic and electric actuators. These actuators fully complement the Bray/McCannalok and directly mount without the need for large brackets or adapters. Bray has designed the most advanced, highest quality line of actuators and Brayline accessories available today.

At left, a Series 92 Pneumatic Actuator with a Series 52 Valve Status Monitor are mounted to a 80mm Series 40 Valve. At right, a Series 70 Electric Actuator is shown mounted to a 80mm Series 40 Valve.



DISTRIBUTOR

All statements, technical information, and recommendations in this bulletin are for general use only. Consult Bray representatives or factory for the specific requirements and material selection for your intended application. The right to change or modify product design or product without prior notice is reserved.



A Subsidiary of BRAY INTERNATIONAL, Inc.
 16-18 Fountain Crescent, Inchinnan Business Park
 Inchinnan PA4 9RE Scotland
 Tel: +44(0)141 812 5199 Fax: +44(0)141 812 6199 www.bray.com
 © 2005 Bray International. All rights reserved. B-1023 5/05